

Cerberus™ PRO

## Fire control panel

FC721





### Compact, pre-assembled fire control panel with integrated, user-friendly operating unit.

- Fire control panel for a maximum of 126 addresses
- Emergency power supply for emergency operating time of up to 72 hours
- Recognition, automatic read-in and immediate operational readiness of all C-NET devices with auto-configuration
- Flexible configuration of complex applications and controls
- Configuration data can be uploaded/downloaded via remote access
- Extensions: Printer, key switches, LED indicators

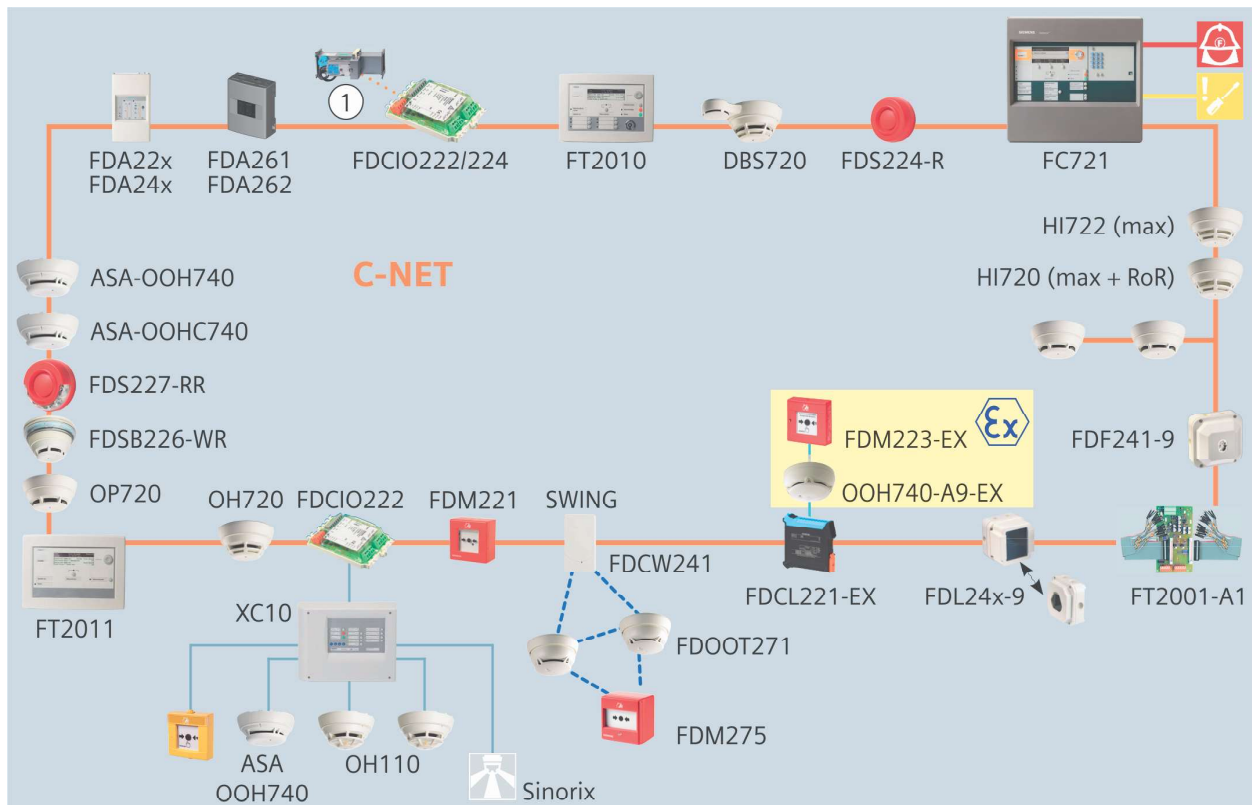
System





1	Fire damper with actuator
	Transmission of a fault signal
	Transmission of an alarm signal

You will find a detailed labeled version of the diagram above along with further information in the A6V10332842 planning guide, see chapter 'Product documentation'.





### General features and functions

- Process signals from Cerberus PRO
- Slots for RS232 and RS485 serial interfaces
- Floor repeater devices, alarm devices, and mimic displays on the C-NET detector line
- All detector lines are monitored for ground faults.
- Integrated degraded mode function
- Freely configurable, time-dependent controls with optional weekly, monthly, and yearly switching programs
- Time and situation-dependent changeover of detector parameter sets
- Controls for synchronous activation of sounder bases/sounders (acoustic, optical, language)
- The control panel and the fire detection system are custom-configured using the 'Cerberus-Engineering-Tool' software
- Firmware for all processor-controlled control panel components can be updated
- Customer texts can be adapted directly on the operating unit of the control panel or with the 'Cerberus-Engineering-Tool' software
- Up to 13000 events can be called up from the event memory and filtered based on various criteria
- Automatic summer/normal time changeover

### Control panel-specific features

FC721-ZZ	Housing (Eco)
	<p>Detector line (C-NET)</p> <ul style="list-style-type: none"> <li>• 126 addresses</li> <li>• 1 loop/2 stubs</li> </ul> <p>Properties</p> <ul style="list-style-type: none"> <li>• Operating unit</li> <li>• 70 W power supply</li> <li>• Max. battery capacity 7 Ah</li> </ul> <p>Options of the operating unit</p> <ul style="list-style-type: none"> <li>• Event printer FTO2001-A1</li> <li>• Key switch (Kaba) FTO2005-C1</li> <li>• Key switch (nordic) FTO2006-B1</li> </ul>
FC721-YZ	Housing (Eco)
	<p>Detector line (C-NET)</p> <ul style="list-style-type: none"> <li>• 126 addresses</li> <li>• 1 loop/2 stubs</li> </ul> <p>Properties</p> <ul style="list-style-type: none"> <li>• Operating unit with LED module</li> <li>• 70 W power supply</li> <li>• Max. battery capacity 7 Ah</li> </ul> <p>Options of the operating unit</p> <ul style="list-style-type: none"> <li>• Key switch (Kaba) FTO2005-C1</li> <li>• Key switch (nordic) FTO2006-B1</li> </ul>

## Extensions

<b>FH7201-Z3</b> 	<b>Housing (Eco)</b> <ul style="list-style-type: none"><li>• Empty housing for free use</li><li>• 443 x 404 x 108 mm</li><li>• E.g., for extra batteries, operating add-ons, or event printers</li><li>• Space for the following battery configuration:<ul style="list-style-type: none"><li>– 2x FA2003-A1 (7 Ah)</li></ul></li></ul>
<b>FH7202-Z3</b> 	<b>Housing (Standard)</b> <ul style="list-style-type: none"><li>• Empty housing for free use</li><li>• 443 x 404 x 188 mm</li><li>• E.g., for extra batteries, operating add-ons, or event printers</li><li>• Space for the following battery configuration:<ul style="list-style-type: none"><li>– 2x FA2004-A1 (12 Ah)</li></ul></li></ul>
<b>FTO2001-A1</b> 	<b>Event printer</b> <ul style="list-style-type: none"><li>• Thermal printer for installation in operating units or operating add-ons</li><li>• Can be controlled via the RS232 module FCA2001-A1 (order separately)</li><li>• Logs all important events, such as alarms, faults, isolations, and test functions</li></ul>
<b>DL3750+</b> 	<b>Matrix printer (external)</b> <ul style="list-style-type: none"><li>• External matrix printer recommended by Siemens</li><li>• Supports monitoring for printing faults</li><li>• Can be controlled via the RS232 module FCA2001-A1 (order separately)</li><li>• Can be controlled via Ethernet via the print server PS104 from SEH</li></ul>

## Use

For smaller-scale applications, e.g., workshops or hotels.

## Design

### Function elements

#### Operating unit

The following elements are available on the operating unit:

- CPU module and electronics
- Ethernet connection
- Slots for RS232 and RS485 modules
- Space for 'Kaba' or 'nordic' key switch
- Space for event printer (depending on version)

### **Periphery board**

The following elements are available on the periphery board:

- Connection terminals for:
  - C-NET lines
  - Remote transmission (alarm, fault)
  - Horn output
  - Configurable control inputs and outputs
  - Monitored alarm and fault output
  - Power supply and emergency supply

### **Power supply 70 W, emergency power supply**

The power supply feeds the hardware and charges the batteries.

In the event of a power cut, the batteries provide emergency current.

### **Configuration**

The following software allows the system to be customized:

- Cerberus-Engineering-Tool

Each control unit has an integrated operating unit.

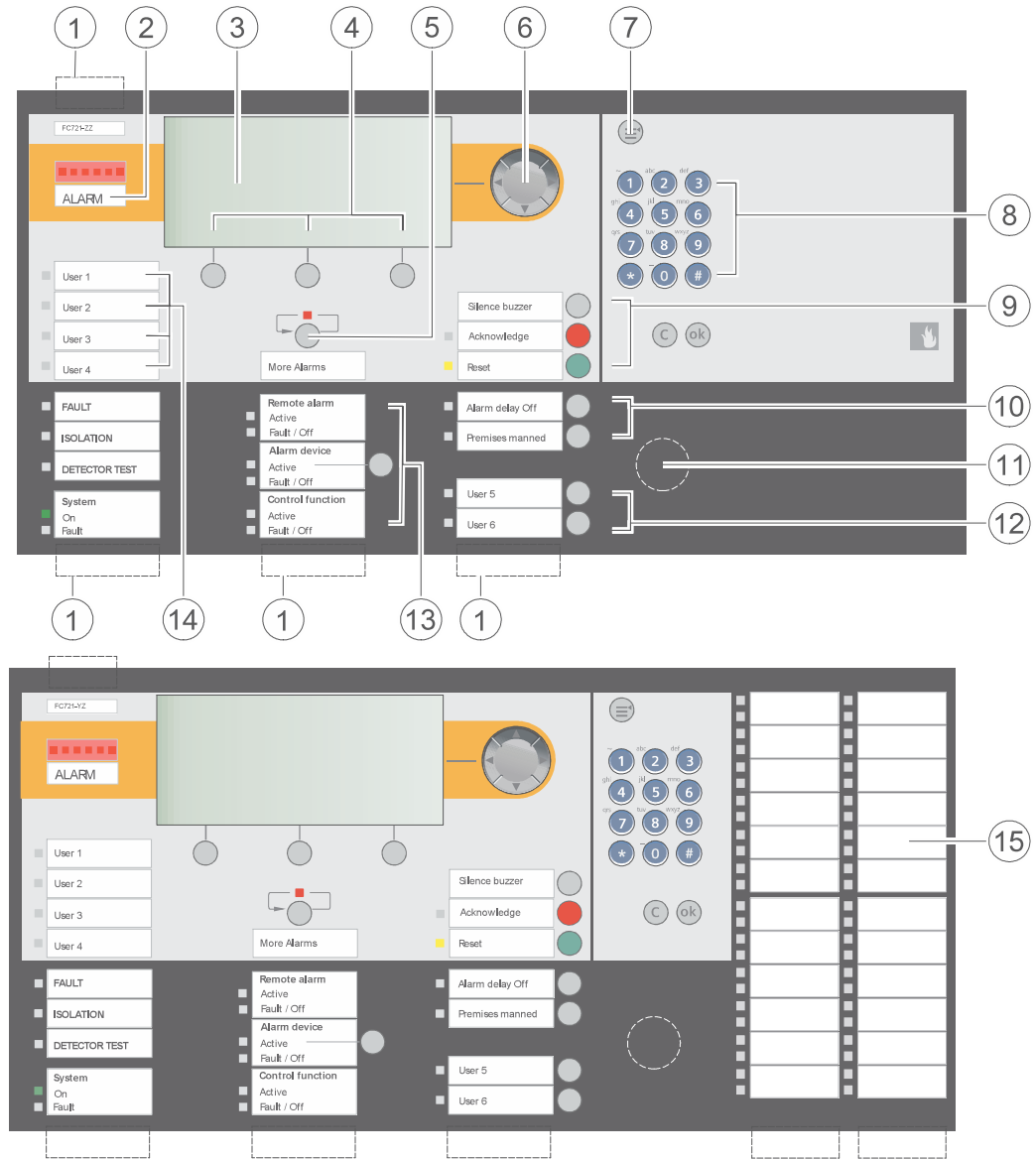

Fig. 1: Indication and operating elements

Position	Comment
1	Insertable inscription strips
2	Alarm indicator, lights up red when an alarm event occurs
3	Backlit 8-line LC display with 40 characters per line and detailed text information about all events that occur: <ul style="list-style-type: none"> <li>• Event type, event location, action texts, operating states</li> <li>• Instructions displayed directly in alarm situations to tell you what to do</li> <li>• Convenient operation via soft keys and navigation button</li> </ul>
4	Soft keys for direct operation depending on state
5	Button for scrolling through alarm messages
6	Navigation button
7	Menu button
8	Keypad for entering numeric and alphanumeric texts, e.g., password or customer text
9	Buttons for 'Buzzer off', 'Acknowledge' message, and 'Reset' message
10	Alarm organization buttons
11	Optional key switch for operating access (Kaba or nordic)
12	Two buttons with LEDs, individually configurable
13	Button and LEDs with inscription fields for alarming equipment
14	Four configurable LEDs and associated inscription fields
15	Optional 24 indicator groups with one red/green and one yellow LED each

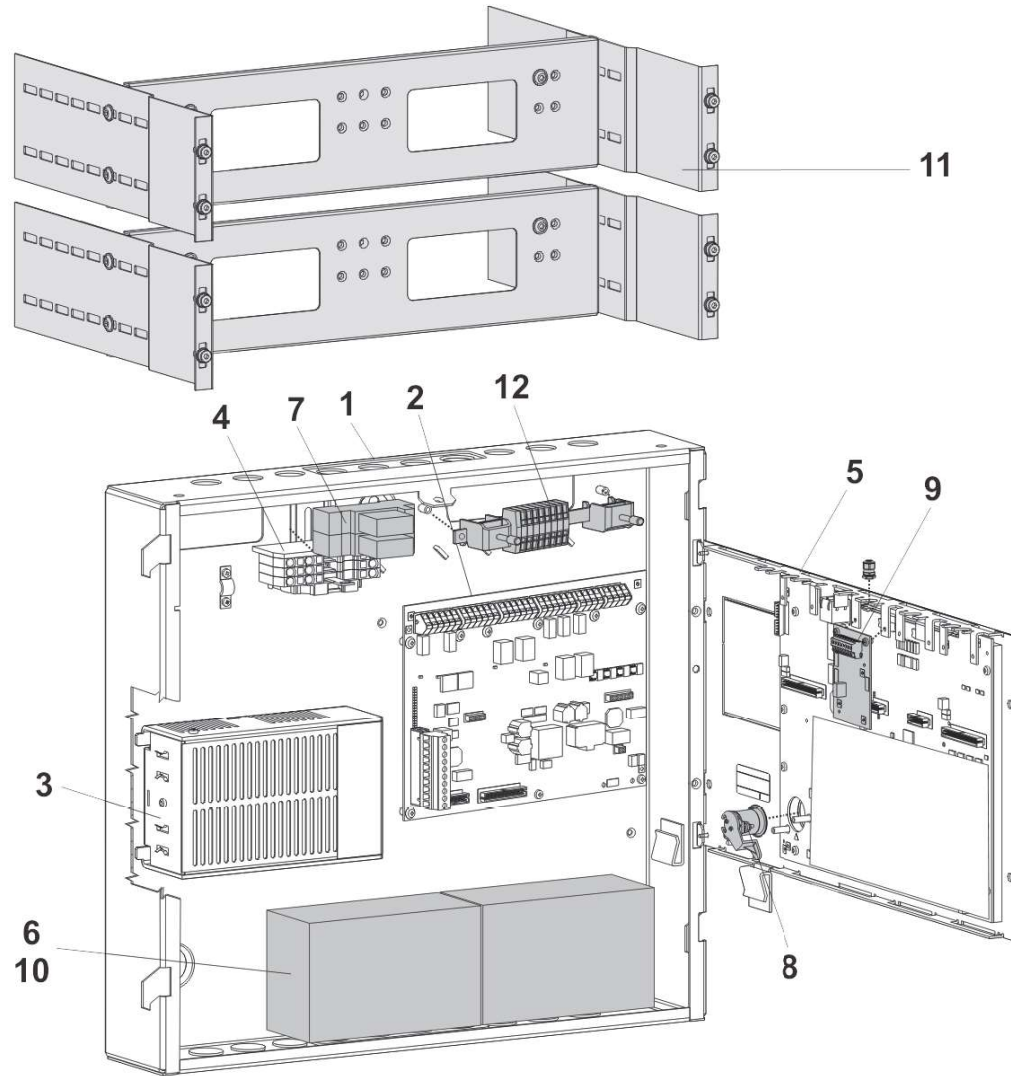



Fig. 2: Layout of FC721

Position	Designation	Type	Comment	
<b>Basic equipment</b>				
1	Housing (Eco)	FH7201-A1	Items 1-5: Basic equipment	
2	Periphery board (1-loop)	FCI2010-A1		
3	Power supply (70 W)	FP2015-A1		
4	Mains terminals on TS35 DIN rail	-		Space for two relay modules
5	Operating unit	FCM72xx-xx		Operating unit with CPU
6	Space for batteries	-	2x 12 V / 7 Ah	
<b>Extensions</b>				
7	Relay module	Z3B171	Relay for fire controls	
8	Key switch (Kaba)	FTO2005-C1	For operating access authorization	
	Key switch (nordic)	FTO2006-B1		
9	RS485 module (isolated) or	FCA2002-A1	For peripheral devices with RS485 interface	
	RS232 module (isolated)	FCA2001-A1	For devices with an RS232 interface	
10	Battery (12 V, 7 Ah, VdS)	FA2003-A1	For the emergency power supply	
11	19" mounting kit	FHA2016-A1	For installation in 19" third-party housing	

Position	Designation	Type	Comment
12	Cable kit (communication)	FCA2014-A1	For flexible connections running to the modules on the operating unit

### Type Overview

	Housing (Eco)	
		
Type	FC721-ZZ	FC721-YZ
Order number	S54400-C32-A2	S54400-C32-A3
Number of C-NET addresses	126	
Number of lines:		
Loops or	1	
Stubs	2	
Power supply	70 W	
Battery size	7 Ah	
Indicator groups with one red/green + one yellow LED each	-	24

### Control panels

Type	Designation	Weight	Order number
FC721-ZZ	Fire control panel (1L)	6.784 kg	S54400-C32-A2
FC721-YZ	Fire control panel (1L, 1LED)	6.904 kg	S54400-C32-A3

### Extensions

Type	Designation	Weight	Order number
FTO2001-A1	Event printer	0.141 kg	A5Q00010126
DL3750+	Matrix printer (external)	7.300 kg	A5Q00023962
FH7201-Z3	Housing (Eco)	5.518 kg	S54400-B72-A1
FH7202-Z3	Housing (Standard)	7.268 kg	S54400-B70-A1
Z3B171	Relay module 250 V AC / 10 A (1 relay)	0.042 kg	4843830001
FTO2005-C1	Key switch (Kaba)	0.083 kg	A5Q00010113
FTO2006-B1	Key switch (nordic)	0.046 kg	A5Q00010129
FCA2001-A1	RS232 module (isolated)	0.033 kg	A5Q00005327
FCA2002-A1	RS485 module (isolated)	0.027 kg	A5Q00009923
FCA2014-A1	Cable kit (communication)	0.126 kg	A5Q00023027
FHA2016-A1	19" mounting kit	3.000 kg	A5Q00020179

### Auxiliary power supply

Type	Designation	Weight	Order number
FP2004-A1	Power supply kit (150 W, A) for EN-compliant installation in empty housing	1.286 kg	A5Q00020825
FP2015-A1	Power supply (70 W) for EN-compliant installation in empty housing	1.300 kg	S54400-B121-A1
FP120-Z1	Power supply kit A 70 W	3.920 kg	S54400-S122-A1

### Batteries

Type	Designation	Weight	Order number
FA2003-A1	Battery (12 V, 7 Ah, VdS)	2.350 kg	A5Q00019353
FA2004-A1	Battery (12 V, 12 Ah, VdS)	3.750 kg	A5Q00019354
BAT12-25	Battery (12 V, 25 Ah, VdS)	7.8 kg	S54302-Z102-A1
FHA2061-A1	Mounting kit for batteries	–	S54400-B91-A1

Title	Document ID
<b>System documentation</b>	
System description	A6V10210355
Product data	A6V10210368
Planning	A6V10210362
Mounting/Installation	A6V10210390
<b>System data sheet</b>	
FS720 – Fire detection system	A6V10227649
<b>Data sheets</b>	
FC721 - fire control panel	A6V10203220
FC722 - fire control panel	A6V10206525
FC723 - fire control panel for modernization	A6V10379246
FC724 - fire control panel	A6V10207176
FC726 - fire control panel (modular)	A6V10263277
FT724 - fire terminal	A6V10207898
Fire detection system with integrated single-sector extinguishing	A6V11480005
Network Security Guidelines	A6V101039439
Planning overview	A6V10332842
<b>Technical manuals</b>	
FC721 - fire control panel	A6V10211100

Related documents such as the environmental declarations, CE declarations, etc., can be downloaded from the following Internet address:

[www.siemens.com/bt/download](http://www.siemens.com/bt/download)



## Guarantee

The application-specific technical data is guaranteed only in combination with the Siemens products listed in the 'Device combinations' section. If third-party products are used, any guarantee provided by Siemens will be invalidated.

## Technical data

### FC721 fire control panel in housing (Eco)

<b>Supply</b>	Mains voltage	AC 97...127 V / AC 196...253 V
	Power supply	70 W
	Operating voltage	DC 20.5...28.6 V
	Operating current	Max. 2.5 A
	Battery capacity	2x 12 V, 7 Ah
	Battery monitoring	Yes
	Network monitoring	Yes
<b>Inputs / outputs</b>	Connectable detector series	Cerberus PRO (C-NET)
	Number of addresses	Max. 126
	Number of integrated line cards	1
	Number of lines:	
	• Loops or	1
	• Stubs	2
	Integrated inputs/outputs:	
	• Alarm RT relay output	1
	• Fault RT relay output	1
	• Monitored alarm outputs	1
	• Monitored fault outputs	1
• Monitored horn outputs	1	
• Freely programmable inputs/outputs	4	
<b>Interfaces</b>	Operating unit	Integrated
	Slots for serial interfaces RS232, RS485	1
	Mounting space for cable kit (communication)	1
	Ethernet port RJ45	1
<b>Ambient conditions</b>	Operating temperature	-8...+42 °C
	Storage temperature	-20...+60 °C
	Air humidity (no condensation permitted)	≤95 % rel.
	Maximum height above sea level	4000 m
<b>Mechanical data</b>	Dimensions (W x H x D):	
	• Without cover cap	430 x 398 x 85 mm
	• With cover cap	443 x 404 x 108 mm
	Protection category (IEC 60529)	IP30
	Color:	
	• Housing	~RAL 7035 light gray
• Cover cap	~RAL 000 50 00	
<b>Approvals</b>	VdS	—
	LPCB	126bn/05
	FM	3051081



Issued by  
Siemens Switzerland Ltd  
Smart Infrastructure  
Global Headquarters  
Theilerstrasse 1a  
CH-6300 Zug  
+41 58 724 2424  
[www.siemens.com/buildingtechnologies](http://www.siemens.com/buildingtechnologies)

© Siemens 2007  
Technical specifications and availability subject to change without notice.

---

Document ID    A6V10203220\_I\_en\_--  
Edition        2023-07-06