



Room thermostat with Auto Timer, Option External Input RDE100..

for heating systems

-
- Room temperature control
 - 2-position control with On/Off output for heating
 - Comfort, Economy, Auto timer and Protection mode
 - Auto time switch
 - Adjustable commissioning and control parameters
 - Mains-powered AC 230 V (RDE100) or battery-powered DC 3 V (RDE100.1)
 - Multifunction input (RDE100.1 only) for external floor sensor, keycard contact, etc.

Use

The RDE100.. is used to control the room temperature in heating systems.

Typical applications:

- Apartments
- Commercial spaces
- Schools

For the control of the following pieces of equipment:

- Thermal valves or zone valves
- Gas or oil boilers
- Fans
- Pumps
- Floor Heating

Functions

- Room temperature control via built-in sensor or external input
- Selection of operating mode with operating mode touchkey
- Setting auto time switch (individual day, 7 day or 5-2 day)
- Display of current room temperature or setpoint in °C or °F
- Touchkey lock (manually)
- Setpoint lock
- Periodic pump run
- Reloading factory settings for commissioning and control parameters
- One multifunctional input (RDE100.1 only) freely selectable for:
 - Floor Heating temperature limitation function
 - Operating mode switchover contact (keycard, window contact, etc.)

Temperature control

The RDE100.. acquires the room temperature with its built-in sensor and maintains the setpoint by delivering control commands. The switching differential is 1 K.

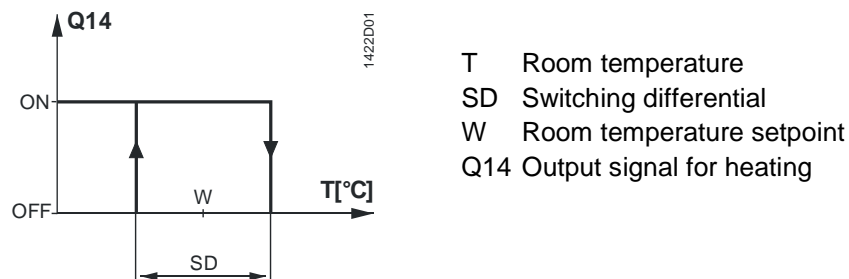

Floor heating limitation function (RDE100.1 only)

The factory setting for this function is Off (disabled) and must be set to "On" if floor heating is used.

The external floor temperature sensor is connected to input X1, 1 and acquires the floor temperature. If the floor temperature exceeds the parameterized temperature limit xx °C (P14 = 1, P15 = 1, P16 = xx °C), the heating valve is fully closed until the floor temperature returns to a level below the parameterized limit. Typical application is rooms (dry floor).

If the application does not require floor heating temperature limitation but instead uses the external sensor as a source for both room temperature display and control, the parameters will have to be set as follows: P14 = 1, P15 = 0. A typical application is the bathroom (wet floor) where a constant floor temperature is required.

It is not recommended to have **only** an internal built-in room sensor for floor heating since there is a potential risk of overheating.

Operating mode switchover function

This function allows keycard application, please refer to the section "Operating notes, Economy mode".

Periodic pump run function

Can only be used when circulating pump or valve is controlled!

This function protects the pump or valve against seizing during longer off periods. Periodic pump run is activated for 3 minutes every 24 hours at 12:00.

Parameter	Pump status
P12 = 0 (Default)	Pump run off
P12 = 1	Pump run on

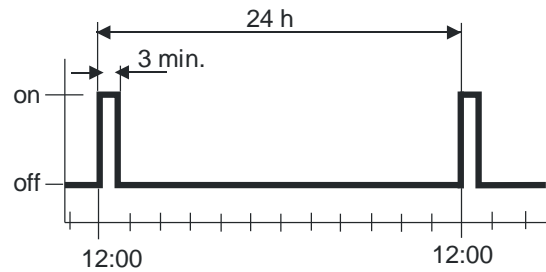

1422704

Type summary

Product No.	Stock No.	Features
RDE100	S55770-T278	Mains-powered AC 230 V
RDE100.1	S55770-T279	Battery-powered DC 3 V









Ordering

- When ordering, please indicate product No. / stock No. and description.
- Example:

Product No.	Stock No.	Description
RDE100	S55770-T278	Room thermostat

Valve actuators/external sensor must be ordered separately.

Equipment combinations

Description		Product No.	Data Sheet
Electromotoric actuator		SFA21..	4863
Electrothermal actuator (for radiator valves)		STA23..	4884
Electrothermal actuator (for small valves 2.5 mm)		STP23..	4884
Damper actuator		GDB..	4634
Damper actuator		GSD..	4603
Damper actuator		GQD..	4604
Rotary damper actuator		GXD..	4622
Cable temperature sensor		QAH11.1	1840
Room temperature sensor		QAA32 ..	1747

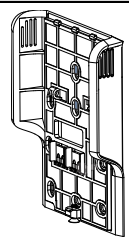
Description		Product No.	Mounting Instruction
Adapter plate (for China 86 conduit box, BS4662 UK conduit box)		ARG70.5	A6V10563479

Mechanical design

The room thermostat consists 2 parts:

- Plastic housing which accommodates the electronics, the operating elements and the room temperature sensor
- Mounting plate with screw terminals

The housing engages in the mounting plate and is secured with a screw.

Operation and settings



- 1) Operating mode touch key
- 2) Set
- 3) Ok
- 4) Touch key for decreasing a value
- 5) Touch key for increasing a value

Display

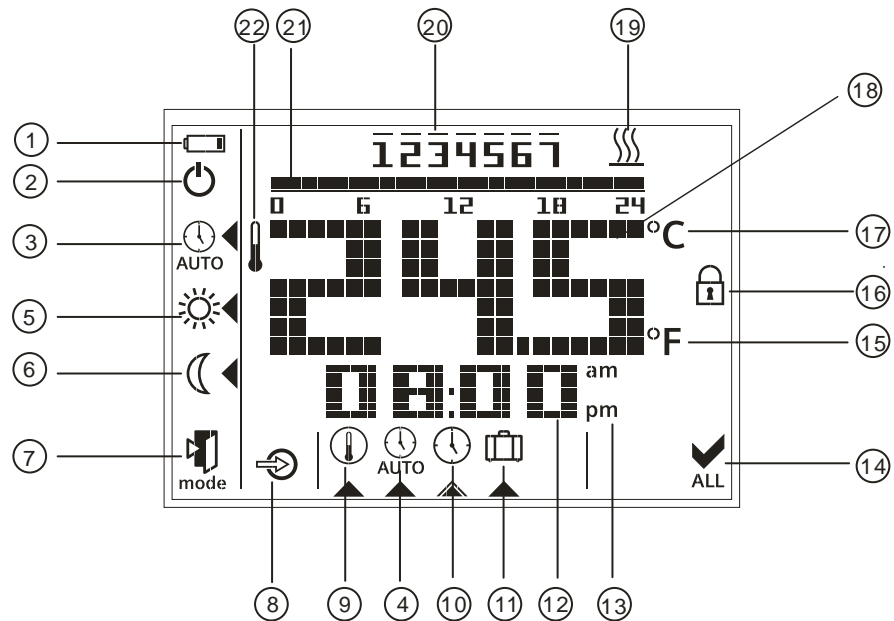

#	Symbol	Description	#	Symbol	Description
1		Indicating that batteries need to be replaced (only with battery-powered version RDE100.1)	12		Display of time
2		Protection mode (protection mode symbol can be enabled via parameter settings)	13	am pm	Morning: 12-hour format Afternoon: 12-hour format
3		Auto timer mode	14	 ALL	Confirmation
4		View and set auto time switch	15	°F	Room temperature in degrees Fahrenheit
5		Comfort mode	16		Touch key lock activated
6		Economy mode	17	°C	Room temperature in degrees Celsius
7		Escape	18	24.5	Display of room temperature, set point, etc.
8		External input enabled (RDE100.1 only)	19		Heating On
9		Permanent set point setting	20	1234567	Weekday 1 = Monday 7 = Sunday
10		Day and time setting	21		Timer bar
11		Holiday mode setting	22		Current room temperature

Mounting and installation notes

Do not mount the thermostat in niches or bookshelves, not behind curtains, not above or near heat sources, and not exposed to direct solar radiation. Mount about 1.5 m above the floor.

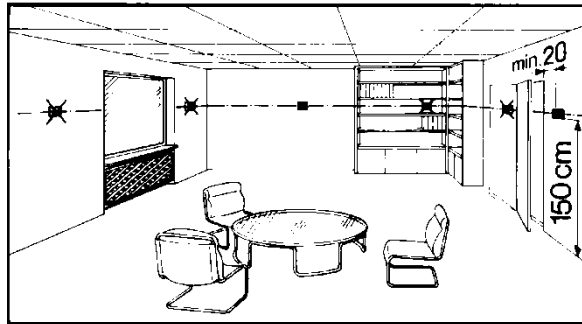

Mounting



- Mount the thermostat in a clean and dry location without direct air flow from a heating/cooling equipment, and not exposed to drip or splash water
Note: When RDE100.. is equipped with either China 86 conduit box or BS4662 UK conduit box, ARG70.5 adapter plate is suggested to provide a better fitting installation.

Wiring

See Mounting Instructions M1429 enclosed with the thermostat.



- Ensure that wiring, protection and earthing comply with local regulations



- Correctly size the cables to the thermostat and the valve actuators



- Use only valve actuators rated for AC 24...230 V



Warning!

No internal line protection for supply lines to external consumers.

Risk of fire and injury due to short-circuits!



- Adapt the line diameters as per local regulations to the rated value of the installed overcurrent protection device



- The AC 230 V mains supply line must have a circuit breaker with a rated current of no more than 10 A



- Disconnect from power supply before removing the unit from its mounting plate



- External Inputs X1, \perp may carry mains potential. Sensor cables or window contact must carefully install before powering up the thermostat

Commissioning notes

Commissioning

After power is applied, the thermostat carries out a reset during which all LCD segments flash, indicating that the reset was made correctly. After the reset, the thermostat is ready for commissioning by qualified HVAC personnel.

The control parameters of the thermostat can be set to ensure optimum performance of the entire system. Please refer to Operating Instructions CB1B1422, section "Do you want to change parameters?".

Sensor calibration

If the temperature on the display does not agree with the room temperature effectively measured, the temperature sensor can be recalibrated. For that purpose, adjust parameter P04.

Setpoint lock

We recommend reviewing the setpoint lock (for public areas) in parameters P06 and P08 and changing them as needed.

Touchpad scanning rate

Since the thermostat uses touch technology and to minimize battery power consumption, a parameter P21 (adjustable from 0.25 to 1.5 seconds) is implemented for the user to adjust. This function is only valid for the battery-powered version and the default value is 1 second.

This means that when, for a certain time, the user does not touch the touchpad, the unit operates in power saving mode and the touchpad is running at a scanning rate of 1 second.

(From the calculation – assuming 4 operations per day on the thermostat, the estimated 1-second scanning rate results in a battery life of 1 year. If the user increases the scanning rate, the batteries' life is extended.)

Change of batteries (only with battery-powered version RDE100.1)

If the battery symbol  appears, the batteries are almost exhausted and should be replaced. Use alkaline batteries type AAA.

Operating notes

The RDE100.. provides Comfort, Economy, Auto timer and Protection mode. The difference between Comfort and Economy mode is only the room temperature setpoint. The changeover between Comfort, Economy and Protection mode is made either automatically by the auto time switch or by pressing touchkey **mode**.

Comfort mode

When Comfort mode is activated, symbol  appears on the display. The setpoint (20 °C) can be readjusted by pressing touchkeys + and –.

Economy mode

When Economy mode is activated, symbol  appears on the display. The setpoint (16 °C) can be readjusted by pressing touchkeys + and –.

In **RDE100.1**, a window contact feature is that a user can connect a window contact to the input X1, . Depending on whether the window contact is configured to Normally Open or Normally Close (Parameter P14 = 2, Parameter P17 = 0 or 1), a change in this status will automatically switch the thermostat from any modes to Economy mode. This feature is good for public area. The factory setting for this function is Off (disabled).

Protection mode

If the temperature falls below 5 °C, the unit automatically activates the heating output. The symbol  appears only, if the icon is enabled via parameter settings.

Time switch

When Auto timer mode is enabled, the changeover between the operating modes (Comfort and Economy mode) will take place automatically. There are three options for time switch setting: individual day, 7 day or 5-2 day. You can select Comfort or Economy mode in every 15 minutes interval of the day. The 0:00 to 24:00 hour time bar will allow you to set the mode throughout the selected day(s).

Default value	Day/s	Comfort mode	Economy mode
	Mo (1) – Fr (5)	6:00 – 8:00 hr 17:00 – 22:00 hr	22:00 – 6:00 hr 8:00 – 17:00 hr

	Sa (6) – Su (7)	7:00 – 22:00 hr	22:00 – 7:00 hr
--	-----------------	-----------------	-----------------

Please refer to Operating Instructions CB1B1422, section "Do you want to enter your own time switch?"

Holiday mode

When holiday mode is activated, symbol  appears on the display. The set point (12 °C) and the number of days a user is away can be readjusted by pressing touch keys + and –.

Maintenance notes

The thermostats are maintenance-free.



Disposal



The devices are considered electronics devices for disposal in term of European Directive 2012/19/EU and may not be disposed of as domestic waste.

- Dispose of the device via the channels provided for this purpose.
- Comply with all local and currently applicable laws and regulations.
- Dispose of empty batteries at designated collection points.

Technical data

	Power supply	Operating voltage			
		<ul style="list-style-type: none"> RDE100 at L - N 	AC 230 V +10/-15%		
		Frequency	50 Hz		
		Power consumption	4 VA		
		<ul style="list-style-type: none"> RDE100.1 	DC 3 V (2 x 1.5 V alkaline batteries AAA)		
		For battery life (RDE100.1), see below (alkaline batteries type AAA). Battery life calculation is based on the touchpad scanning rate during idle time (assuming a user presses 4 touch keys per day):			
		Scanning rate 0.25 s	194 days battery life		
		Scanning rate 0.50 s	274 days battery life		
		Scanning rate 1.00 s	346 days battery life		
		Scanning rate 1.50 s	379 days battery life		
Control inputs	Control input Q11-Nx (Com)				
	<ul style="list-style-type: none"> Rating RDE100 	(AC 24...230 V)	Max. 5(2) A	Min. 8 mA	
	<ul style="list-style-type: none"> Rating RDE100.1 	(AC 24...230 V)	Max. 5(2) A	Min. 8 mA	
External sensor (RDE100.1 only)	External sensor				
	'X1' - '⊥' (Reference)	NTC3K/QAH11.1/QAA32			
	Or				
	Digital On/Off				
	'X1' - '⊥' (Reference)	On/Off switch			
Control outputs	Control output Q12-Nx (NC contact)				
	Rating RDE100	(AC 24...230 V)	Max. 5(2) A	Min. 8 mA	
	Rating RDE100.1	(AC 24...230 V)	Max. 5(2) A	Min. 8 mA	
	Control output Q14-Nx (NO contact)				
	Rating RDE100	(AC 24...230 V)	Max. 5(2) A	Min. 8 mA	
	Rating RDE100.1	(AC 24...230 V)	Max. 5(2) A	Min. 8 mA	
	No internal fuse.				
	External preliminary protection with max. C 10 A circuit breaker in the supply lines required under all circumstances.				
	External protection for incoming cable				
	Circuit breaker	Max. 10 A			
	Circuit breaker tripping characteristic	Type B, C or D to EN 60898 and EN 60947			
Function data	Switching differential SD	1 K			
	Comfort mode	20 °C (5...35 °C)			
	Economy mode	16 °C (5...35 °C)			
	Holiday mode	12 °C (5...35 °C) (Standalone)			
	Built-in room temperature sensor				
	Setpoint setting range	5...35 °C (Comfort/Economy mode)			
	Accuracy at 25 °C	< ±0.5 K			
	Temperature calibration range	±3.0 K			
	Resolution of settings and displays				
	Setpoints	0.5 °C			
	Temperature value displays	0.5 °C			
Environmental conditions	Operation	As per IEC 60721-3-3			
	Climatic conditions	Class 3K5			
	Temperature	0...50 °C			
	Humidity	<95% r.h.			

Transport	As per IEC 60721-3-2		
	Climatic conditions	Class 2K3	
Temperature	-25...60 °C		
	Humidity	<95% r.h.	
Mechanical conditions	Class 2M2		
Storage	As per IEC 60721-3-1		
	Climatic conditions	Class 1K3	
Temperature	-25...60 °C		
	Humidity	<95% r.h.	
Norms and standards	EU Conformity (CE)	CE1T1420xx *)	
	RCM conformity	CE1T1420en_C1*)	
	Safety class	II as per EN 60730-1, EN 60730-2-9	
	Pollution class	II as per EN 60730-1	
	Degree of protection of housing	IP30 as per EN 60529	
	Environmental compatibility	The product environmental declaration CE1E1420xx *) contains data on environmentally compatible product design and assessments (RoHS compliance, materials composition, packaging, environmental benefit, disposal).	
		Based on EU Regulation 813/2013 (Eco design directive) and 811/213 (Labeling directive) concerning space heaters, combination heaters, the following classes apply: - Application with On/Off operation of a heater Class I value 1.0%	
	General	Connection terminals for	Solid wires or prepared stranded wires 2 x 1.5 mm ² or 1 x 2.5 mm ² (Min. 0.5 mm ²)
Weight		0.166 kg	
Color of housing front		RAL9003	

*) The documents can be downloaded from <http://siemens.com/bt/download>.

Connection diagrams

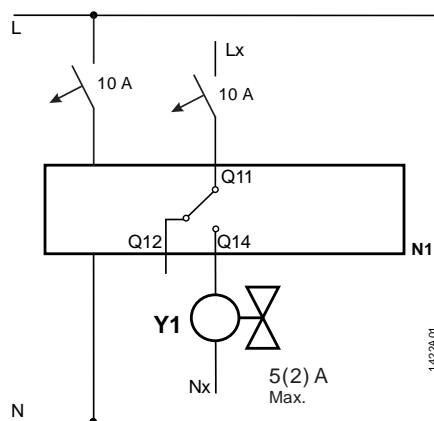

RDE100

N1	Room thermostat
Y1	Valve actuator
L	Live, AC 230 V
N	Neutral conductor, AC 230 V

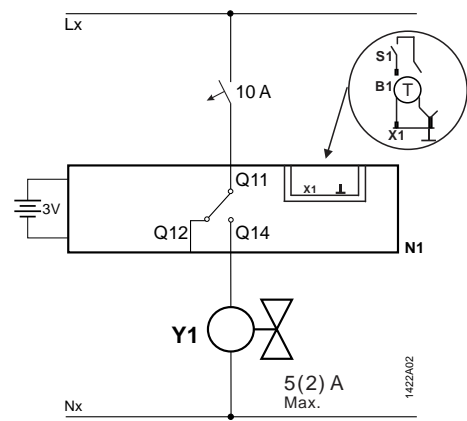

RDE100.1

Lx	Live, AC 24 ... 230 V
Q11, Q12	NC contact (for NO valves)
Q11, Q14	NO contact (for NC valves)
Nx	Neutral conductor, AC 24...230 V
X1	External input signal
⌋	Measuring neutral for external input
B1	Temperature sensor (Floor temperature limit)

S1 Switch (keycard, window contact)

Application examples

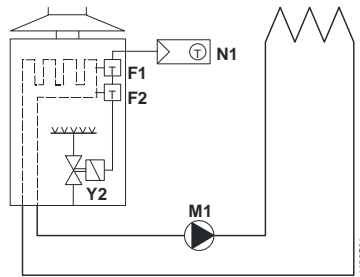

Room thermostat with direct control of a gas-fired wall-hung boiler

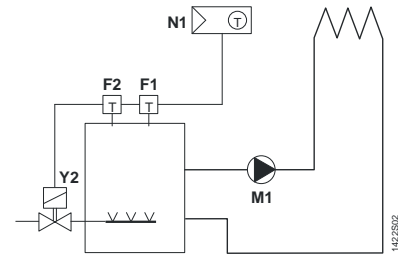

Room thermostat with direct control of a gas-fired floor-standing boiler

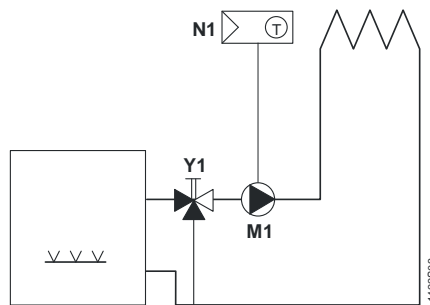

Room thermostat with direct control of a heating circuit pump (precontrol by manual mixing valve)

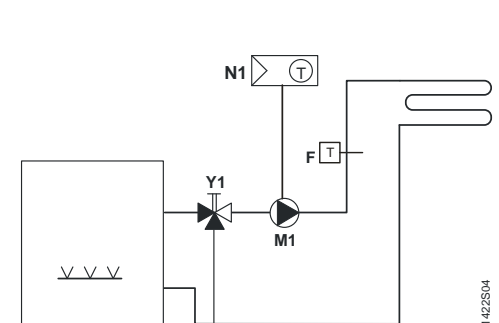

Room thermostat with direct control of hydronic floor heating system

F1 Thermal reset limit thermostat
 F2 Safety limit thermostat
 M1 Circulating pump

N1 RDE100.. room thermostat
 Y1 Mixing 3-port valve with manual adjustment
 Y2 Magnetic valve

Remarks

Heating:

Because of the unavoidable self heating effects of the electrical current, any loads of more than 3 Amperes connected to the unit can influence the control behavior and temperature accuracy in a negative way.

Dimensions

All dimensions in mm

