

Sinteso™

Fire control panel

FC2040



Compact, pre-assembled fire control panel with integrated, user-friendly operating unit.

- Fire control panel for max. 504 addresses
- Optional, integrated single-sector extinguishing
- Can be used as a standalone version or networked with up to 64 stations, such as control panels and terminals
- Redundant network node with degraded mode operation according to EN 54
- Option to connect to Siemens 'Cloud for Buildings'
- Emergency power supply for emergency operating time of up to 72 hours
- Recognition, automatic read-in and immediate operational readiness of all FDnet devices with auto-configuration
- Flexible configuration of complex applications and controls
- Configuration data can be uploaded/downloaded via remote access
- Time and situation-dependent changeover of detector parameter sets
- Extensions: Printer, key switches, LED indicators



The diagrams have been simplified and do not include additional network hardware or security components. Permissible applications are described in the A6V101039125 Network Security Guidelines document. Contact your Siemens IT security expert for more information.

System overview

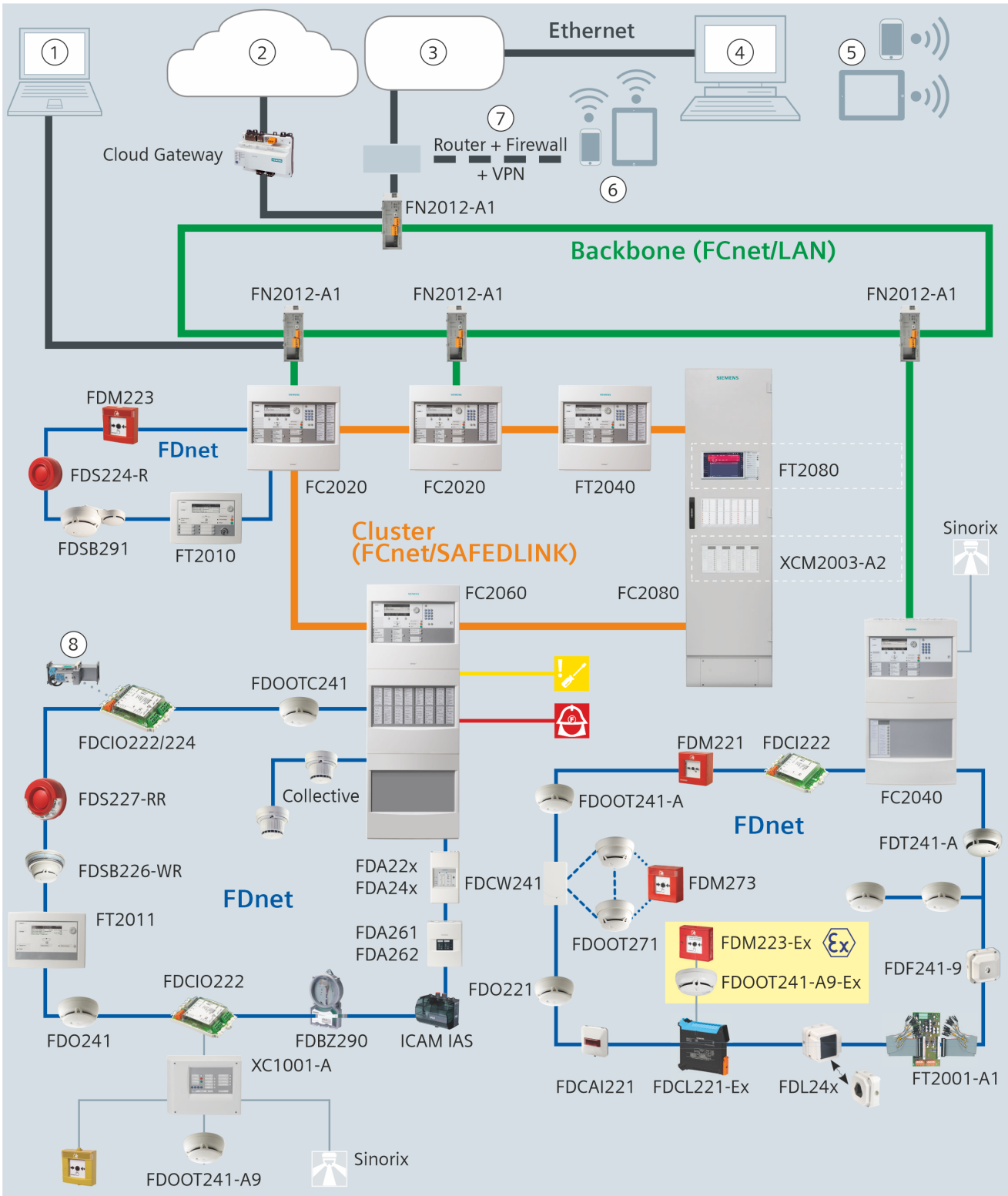



Fig. 1: System overview

1	Remote access with SintesoView
2	'Cloud for Buildings'
3	Customer network
4	Management platform
5	Remote access to management platform
6	Remote access with Sinteso Mobile
7	Router + firewall + virtual private network
8	Fire damper with actuator
	Transmission of a fault signal
	Transmission of an alarm signal

You will find a detailed labeled version of the diagram above along with further information in the A6V10906627 planning guide, see chapter 'Product documentation'.

Networking of fire control panels



The diagrams have been simplified and do not include additional network hardware or security components. Permissible applications are described in the A6V101039125 Network Security Guidelines document. Contact your Siemens IT security expert for more information.

Up to 32 control panels and terminals can be linked to form one FCnet network. If the FCnet network is connected to a danger management system via BACnet, up to 16 control panels and terminals can be networked.

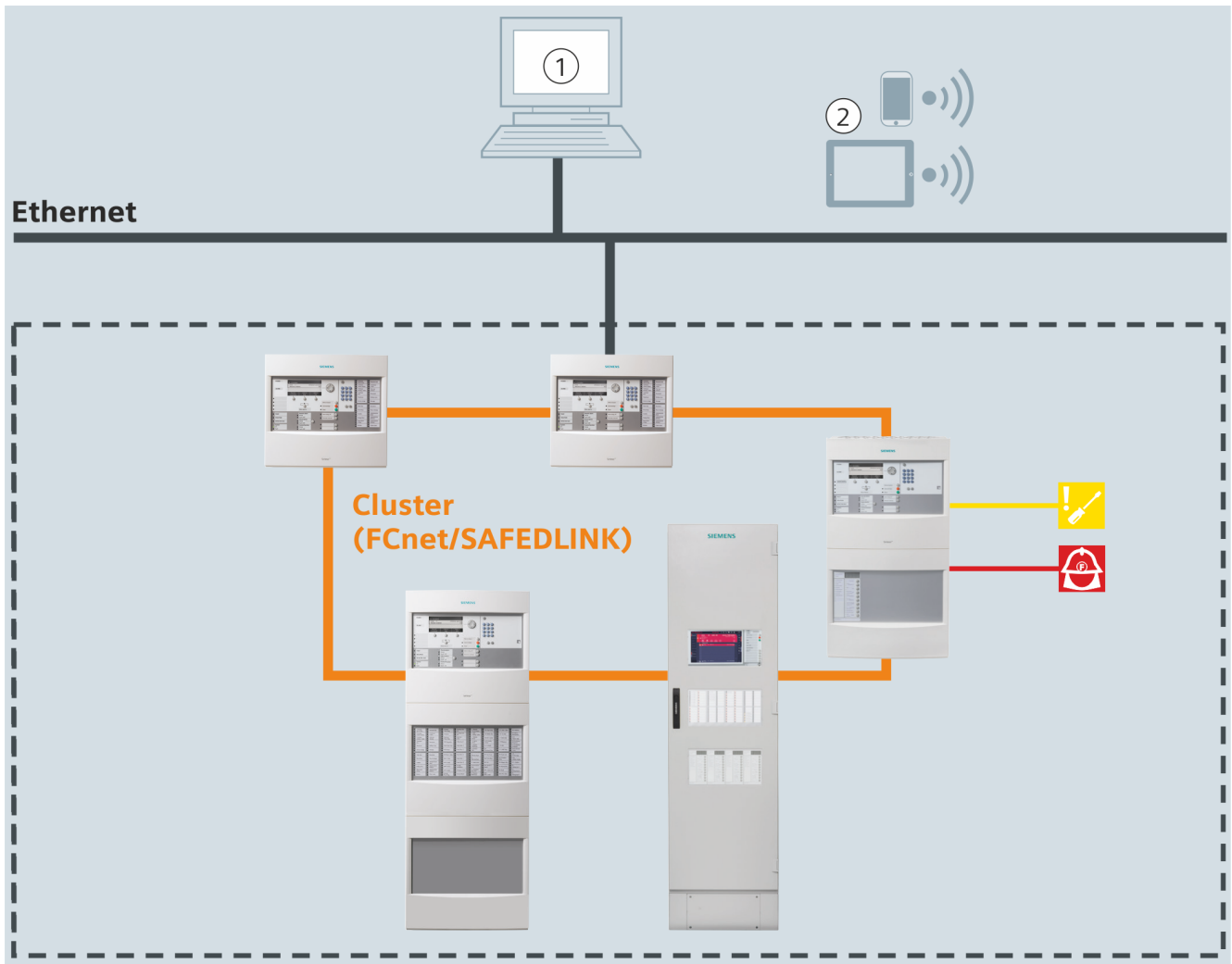

Fig. 2: Sub-net

1	Management platform
2	Remote access to management platform
	Transmission of a fault signal
	Transmission of an alarm signal

An optical FCnet/LAN network allows up to 14 sub-nets with up to 16 stations to be operated in one network. A maximum of 64 stations is supported in total.

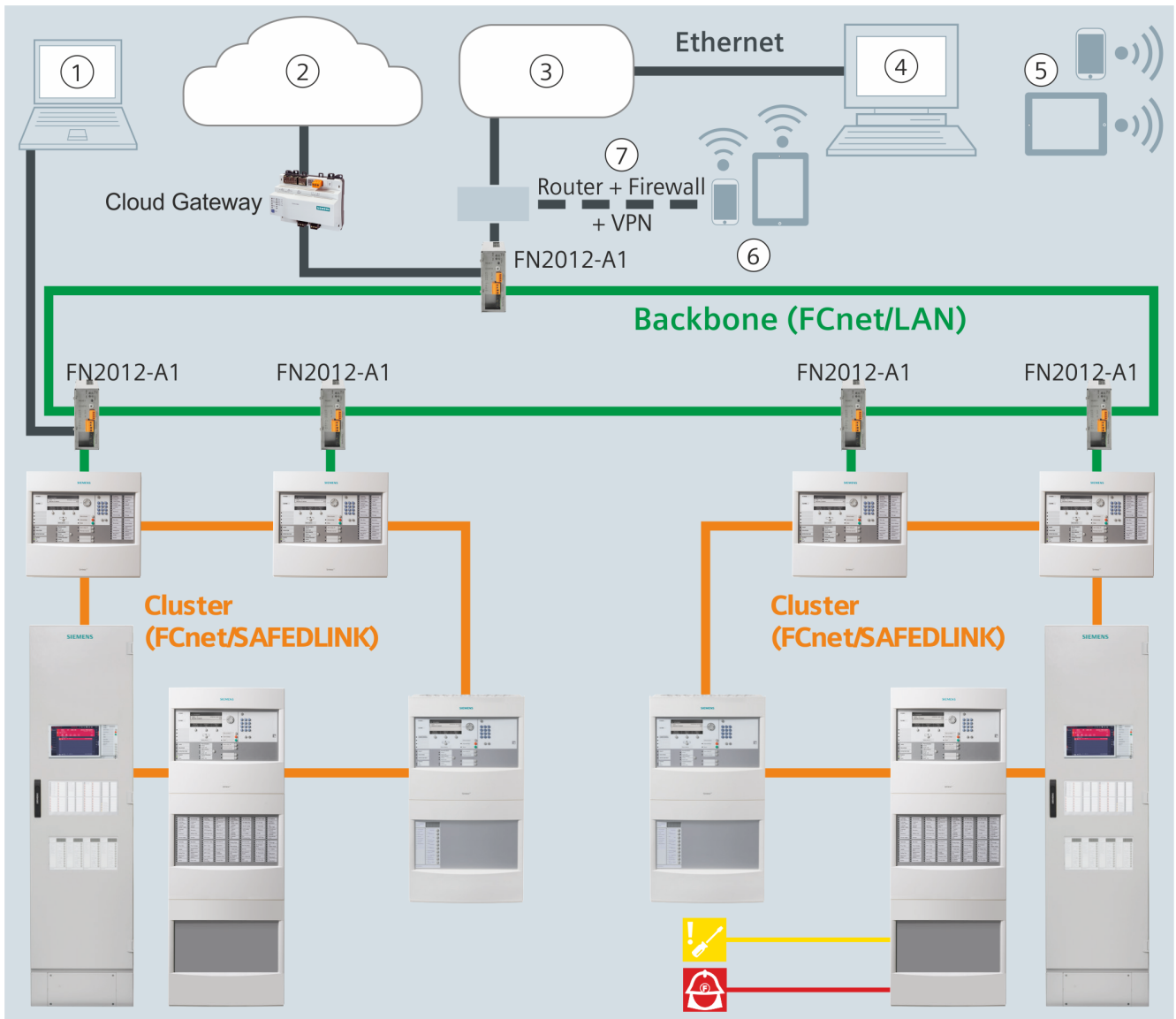



Fig. 3: Backbone

1	Remote access with SintesoView
2	'Cloud for Buildings'
3	Customer network
4	Management platform
5	Remote access to management platform
6	Remote access with Sinteso Mobile
7	Router + firewall + virtual private network
	Transmission of a fault signal
	Transmission of an alarm signal

You will find a detailed labeled version of the diagram above along with further information in the A6V1090627 planning guide, see chapter 'Product documentation'.

General features and functions

- Fast Ethernet interface for a heterogeneous network
- Processes the signals of the Sinteso detector series FD20
- Floor repeater displays, terminals and alarm devices on the FDnet detector line with power supply via FDnet
- Interface to Siemens danger management system
- Slots for RS232 and RS485 serial interfaces
- All detector lines are monitored for ground faults
- Integrated degraded mode function
- Freely configurable, time-dependent controls with optional weekly, monthly, and yearly switching programs
- Time and situation-dependent changeover of detector parameter sets
- Controls for synchronous activation of sounder bases/sounders (acoustic, optical, language)
- The control panel and the fire detection system are custom-configured using the 'SintesoWorks' software
- Firmware for all processor-controlled control panel components can be updated
- Customer texts can be adapted directly on the operating unit of the control panel or with the 'SintesoWorks' software
- Up to 13000 events can be called up from the event memory and filtered based on various criteria
- Automatic summer/normal time changeover

Control panel-specific features





From MP8, the fire control panels can be ordered with a periphery board with a 0.5 A or 1.5 A output current per FDnet line.
To convert existing fire control panels, the periphery board with 1.5 A per FDnet line can be ordered separately.







You will find information on the integrated extinguishing system and the individual extinguishing components that are available in a separate data sheet with the document ID 'A6V10880701'.

FC2040-AA	Housing (Comfort)
	<p>Detector line (FDnet)</p> <ul style="list-style-type: none"> • 504 addresses • 4 loops/8 stubs <p>Properties</p> <ul style="list-style-type: none"> • Operating unit • Operating add-on (empty) • 150 W power supply • Max. battery capacity 25 Ah • 1 flooding zone (optional) <p>Options of the operating unit</p> <ul style="list-style-type: none"> • Event printer FTO2001-A1 • Key switch (Kaba) FTO2005-C1 • Key switch (nordic) FTO2006-B1 • Operating add-on (2xLED indicator) FCM2038-A2 • Operating add-on (4xLED indicator) FCM2036-A2 • Exting. terminal (1 sector) XCM2002-A2

<p>FC2040-AE</p> 	<p>Housing (Comfort)</p> <p>FDnet detector line:</p> <ul style="list-style-type: none"> • 504 addresses • 4 loops/8 stubs <p>Features:</p> <ul style="list-style-type: none"> • Operating unit • Operating add-on (2xLED indicator) • 150 W power supply • Max. battery capacity 25 Ah <p>Operating unit options:</p> <ul style="list-style-type: none"> • Event printer FTO2001-A1 • Key switch (Kaba) FTO2005-C1 • Key switch (nordic) FTO2006-B1
<p>FC2040-AG</p> 	<p>Housing (Comfort)</p> <p>Detector line (FDnet)</p> <ul style="list-style-type: none"> • 504 addresses • 4 loops/8 stubs <p>Properties</p> <ul style="list-style-type: none"> • Operating unit • Operating add-on (4xLED indicator) • 150 W power supply • Max. battery capacity 25 Ah <p>Options of the operating unit</p> <ul style="list-style-type: none"> • Event printer FTO2001-A1 • Key switch (Kaba) FTO2005-C1 • Key switch (nordic) FTO2006-B1
<p>FC2040-GA</p> 	<p>Housing (Large)</p> <p>Detector line (FDnet)</p> <ul style="list-style-type: none"> • 504 addresses • 4 loops/8 stubs <p>Properties</p> <ul style="list-style-type: none"> • Operating unit • 150 W power supply • Max. battery capacity 45 Ah • 1 flooding zone (optional) <p>Options of the operating unit</p> <ul style="list-style-type: none"> • Event printer FTO2001-A1 • Operating add-on (2xLED indicator) FCM2038-A2 • Operating add-on (4xLED indicator) FCM2036-A2 • Exting. terminal (1 sector) XCM2002-A2



You will find information on the integrated extinguishing system and the individual extinguishing components that are available in a separate data sheet with the document ID 'A6V10880701'.

<p>FCM2036-A2</p> 	<p>Operating add-on (4xLED indicator)</p> <ul style="list-style-type: none"> Optional operating add-ons with 96 indicator groups and two LEDs each: 1x red/green LED and 1x yellow LED
<p>FCM2038-A2</p> 	<p>Operating add-on (2xLED indicator)</p> <ul style="list-style-type: none"> Optional operating add-ons with 48 indicator groups and two LEDs each: 1x red/green LED and 1x yellow LED
<p>FH2002-A1</p> 	<p>Housing (Standard)</p> <ul style="list-style-type: none"> Empty housing for free use 430 x 398 x 165 mm E.g., for extra batteries, operating add-ons, or event printers Space for the following battery configuration: <ul style="list-style-type: none"> – 2x FA2004-A1 (12 Ah)
<p>FH2003-A1</p> 	<p>Housing (Comfort)</p> <ul style="list-style-type: none"> Empty housing for free use 430 x 796 x 165 mm E.g., for extra batteries, operating add-ons, or event printers Space for the following battery configurations: <ul style="list-style-type: none"> – 2x FA2005-A1 (17 Ah) or – 2x BAT12-25 (25 Ah) The mounting kit for the batteries FHA2061-A1 must be ordered separately.

FH2004-A1 	Housing (Large Extension) <ul style="list-style-type: none"> • Empty housing for free use • 430 x 398 x 265 mm • E.g., for extra batteries, operating add-ons, or event printer • Space for the following battery configurations: <ul style="list-style-type: none"> – 2x FA2007-A1 (45 Ah) or – 2x FA2008-A1 (65 Ah) • The mounting kit for the batteries FHA2061-A1 must be ordered separately.
FH2005-A1 	Housing (Large) <ul style="list-style-type: none"> • Empty housing for free use • 430 x 796 x 265 mm • E.g., for extra batteries, operating add-ons, or event printers • Space for the following battery configurations: <ul style="list-style-type: none"> – 2x BAT12-25 (25 Ah) or – 2x FA2007-A1 (45 Ah) or – 2x FA2008-A1 (65 Ah) • The mounting kit for the batteries FHA2061-A1 must be ordered separately.
FH2007-A1 	Housing (Standard + plan compartment) <ul style="list-style-type: none"> • Empty housing for A4 documents • 430 x 398 x 165 mm • Depth 150 mm
FTO2001-A1 	Event printer <ul style="list-style-type: none"> • Thermal printer for installation in operating units or operating add-ons • Can be controlled via the RS232 module FCA2001-A1 (order separately) • Logs all important events, such as alarms, faults, isolations, and test functions
DL3750+ 	Matrix printer (external) <ul style="list-style-type: none"> • External matrix printer recommended by Siemens • Supports monitoring for printing faults • Can be controlled via the RS232 module FCA2001-A1 (order separately) • Can be controlled via Ethernet via the print server PS104 from SEH

Use

For medium-sized applications, e.g., for industrial plants, regional banks, or office complexes.
Also suitable for more comprehensive systems thanks to flexible networking options.

Design

Function elements

Operating unit

The following elements are available on the operating unit:

- CPU module and electronics
- Ethernet connection
- Slots for RS232 and RS485 modules and network modules (SAFEDLINK)
- Space for 'Kaba' or 'nordic' key switch
- Space for event printer (depending on version)
- Peripheral data bus connection for optional LED modules

Periphery board



From MP8, the fire control panels can be ordered with a periphery board with a 0.5 A or 1.5 A output current per FDnet line.

To convert existing fire control panels, the periphery board with 1.5 A per FDnet line can be ordered separately.

The following elements are available on the periphery board:

- Connection terminals for:
 - FDnet lines
 - Remote transmission (alarm, fault)
 - Horn output
 - Configurable control inputs and outputs
 - Monitored alarm and fault output
 - Power supply and emergency supply
- 2x slot for loop extension (FDnet)

Power supply unit 150 W, emergency power supply

The power supply feeds the hardware and charges the batteries.

In the event of a power cut, the batteries provide emergency current.

Housing

An FHA2007-A1 pivoting mounting plate can be fitted for the following elements above the periphery board on the rear housing panel:

- 1x fire brigade periphery module (for Germany)
- 2x sounder modules (as an alternative to mounting on U-rail TS35)
- 1x Connect X200 Gateway

Configuration

The following software allows the system to be customized:

- SintesoWorks

Operation

Each control unit has an integrated operating unit. The control panel can also be operated via a separate FT2040 or FT2080 (Touch) fire terminal.

You will find details and more information in the product data sheet 009386 or A6V10378271.

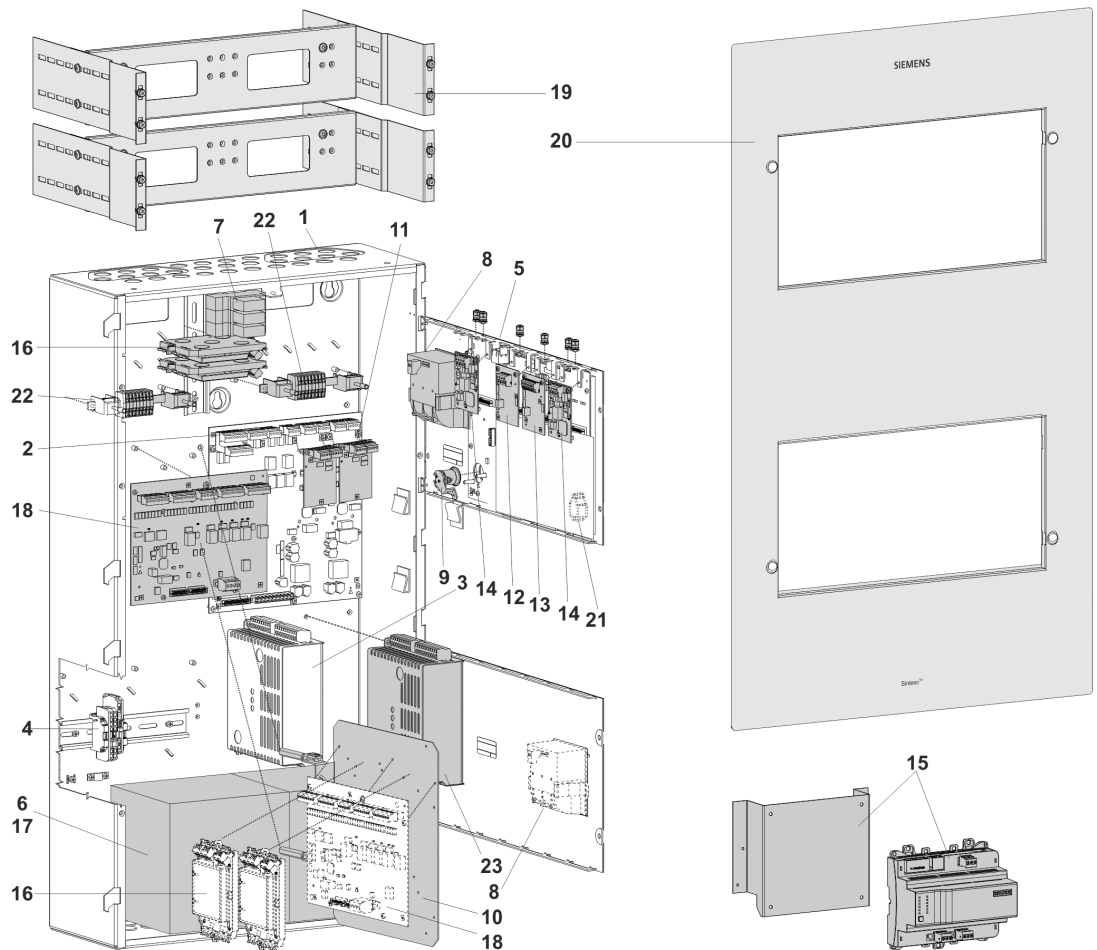





Fig. 4: FC2040 Comfort

Position	Designation	Type	Comment
Basic equipment			
1	Housing (Comfort)	FHA2003-A1	Items 1-5: Basic equipment for each FC2040-xx (Comfort). The periphery board (4 loops, P) can be ordered separately to convert the station to the 1.5 A FDnet line.
2	Periphery board (4 loops)	FCI2004-A1	
	Periphery board (4 loops, P)	FCI2024-A1	
3	Power supply (SV 24 V-150 W)	V24230-Z6-A5	
4	Mains terminals on TS35 DIN rail	-	Space for socket, relay modules, etc.
5	Operating unit	FCM20xx-xx	Operating unit with CPU
6	Space for batteries	-	2x 12 V / 25 Ah
Extensions			
7	Relay module	Z3B171	Relay for fire controls
8	Event printer	FTO2001-A1	For logging events
9	Key switch (Kaba)	FTO2005-C1	For operating access authorization
	Key switch (nordic)	FTO2006-B1	
10	Mounting plate	FHA2007-A1	e.g., for fire brigade periphery module or Connect X200 Gateway

Position	Designation	Type	Comment
11	Loop extension (FDnet)	FCI2003-A1	For loop extension of the periphery board (4 loops) FCI2004-A1 from two to four loops, number of addresses remains the same
	Loop extension (FDnet/C-NET, P)	FCI2025-A1	For loop extension of the periphery board (4 loops, P) FCI2024-A1 from two to four loops, number of addresses remains the same
12	RS485 module (isolated)	FCA2002-A1	For peripheral devices with RS485 interface
13	RS232 module (isolated)	FCA2001-A1	For devices with an RS232 interface
14	Network module (SAFEDLINK)	FN2001-A1	For networking several stations
15	Connect X200 Gateway and mounting plate (X200) FHA2063-A1	CXG3.X200	For connecting an FS20 station to Cloud for Buildings The mounting plate FHA2007-A1 and the accessory set + ACDC (X200) FCA2056-A1 or the mounting plate (X200) FHA2063-A1 and the accessory set + ACDC (X200) FCA2056-A1 must be ordered separately.
16	Sounder module	FCA2005-A1	For splitting one conventional sounder into four
17	Battery (12 V, 25 Ah, VdS)	BAT12-25	For the emergency power supply
18	Fire brigade periphery module	FCI2001-D1	For Germany (FBF, FSD, ÜE, FSE, ÖA, KL)
19	19" mounting kit	FHA2016-A1	For installation in 19" third-party housing
20	FM blind 2HE	FHA2015-A1	For recessed mounting of housing
21	License key Sx	FCA20xx	For special functions
22	Cable kit (communication)	FCA2014-A1	For flexible connections running to the modules on the operating unit
23	Power supply kit (150 W, B)	FP2005-A1	For extra power supply
	Repeater (SAFEDLINK)	FN2002-A1	Not in overview, as not an installation part. For extending the system bus FCnet from 1000 m to 2000 m between two stations. Max. 1x repeater (SAFEDLINK) between two stations

Type Overview

	Housing (Comfort)			Housing (Large)
				
Type	FC2040-AA	FC2040-AE	FC2040-AG	FC2040-GA
Number of FDnet addresses	504			
Number of lines:				
Loops (with loop extension) or	4 (8)			
Stubs (with loop extension)	8 (16)			
Power supply	150 W			
Max. battery capacity	25 Ah			45 Ah
Indicator groups with one red/ green and one yellow LED each	-	48	96	-

Control panels

Type	Designation	Weight	Order number
FC2040-AA	Fire control panel (4 loops)	14.975 kg	A5Q00016100
FC2040-AA	Fire control panel (4 loops, P)	16.607 kg	S54400-C35-A1
FC2040-AE	Fire control panel (4 loops)	15.235 kg	A5Q00016852
FC2040-AE	Fire control panel (4 loops, P)	-	S54400-C35-A2
FC2040-AG	Fire control panel (4 loops)	15.524 kg	A5Q00016854
FC2040-AG	Fire control panel (4 loops, P)	-	S54400-C35-A3
FC2040-GA	Fire control panel (4 loops)	19.626 kg	S54400-C3-A3
FC2040-GA	Fire control panel (4 loops, P)	19.747 kg	S54400-C35-A8

Extensions



You will find information on the integrated extinguishing system and the individual extinguishing components that are available in a separate data sheet with the document ID 'A6V10880701'.

Type	Designation	Weight	Order number
FCA2001-A1	RS232 module (isolated)	0.033 kg	A5Q00005327
FCA2002-A1	RS485 module (isolated)	0.027 kg	A5Q00009923
FCA2005-A1	Sounder module	0.100 kg	A5Q00014866
FCA2014-A1	Cable kit (communication)	0.126 kg	A5Q00023027
FCI2001-D1	Fire brigade periphery module	0.207 kg	A5Q00013100
FCI2003-A1	Loop extension (FDnet)	0.030 kg	A5Q00010136
FCI2024-A1	Periphery board (4-Loop, P)	0.119 kg	S54400-A184-A1
FCI2025-A1	Loop extension (FDnet/C-NET, P)	0.030 kg	S54400-A185-A1
FCM2036-A2	Operating add-on (4xLED indicator)	3.905 kg	S54400-B147-A1
FCM2038-A2	Operating add-on (2xLED indicator)	2.516 kg	S54400-B146-A1
FH2002-A1	Housing (Standard)	7.193 kg	A5Q00018931
FH2003-A1	Housing (Comfort)	11.051 kg	A5Q00009906
FH2004-A1	Housing (Large Extension)	11.367 kg	A5Q00018778
FH2005-A1	Housing (Large)	17.900 kg	A5Q00019543
FH2007-A1	Housing (Standard + plan compartment)	9.430 kg	A5Q00022369
FHA2007-A1	Mounting plate	0.800 kg	A5Q00010151
FHA2015-A1	FM blind 2HE	5.050 kg	A5Q00024621
FHA2016-A1	19" mounting kit	3.000 kg	A5Q00020179
FN2001-A1	Network module (SAFEDLINK)	0.022 kg	A5Q00012851
FN2002-A1	Repeater (SAFEDLINK)	0.105 kg	S24236-B2502-A1
FN2006-A1	Fiber network module (SM)	0.792 kg	S54400-A109-A1
FN2007-A1	Fiber network module (MM)	0.792 kg	S54400-A110-A1
FTO2001-A1	Event printer	0.141 kg	A5Q00010126
-	Spare printer reels (10 reels)	0.090 kg	A5Q00017619

Type	Designation	Weight	Order number
FTO2005-C1	Key switch (Kaba)	0.083 kg	A5Q00010113
FTO2006-B1	Key switch (nordic)	0.046 kg	A5Q00010129
Z3B171	Relay module 250 V AC / 10 A (1 relay)	0.042 kg	4843830001

Auxiliary power supply

Type	Designation	Weight	Order number
FP2004-A1	Power supply kit (150 W, A) for EN-compliant installation in empty housing	1.286 kg	A5Q00020825
FP2005-A1	Power supply kit (150 W, B) for extension	1.181 kg	A5Q00018779

Network (backbone)

Type	Designation	Weight	Order number
FCA2031-A1	Connection module (MoNet)	0.081 kg incl. cable	S54400-A153-A1
FHA2029-A1	Mounting kit (switch)	1.261 kg	S54400-B79-A1
FN2012-A1	Ethernet switch (modular)	0.600 kg	S54400-B152-A1
VN2002-A1	Ethernet module (MM)	0.026 kg	S54400-A43-A1
VN2003-A1	Ethernet module (SM)	0.026 kg	S54400-A44-A1

Cloud Gateway

Type	Designation	Weight	Order number
CXG3.X200	Connect X200 Gateway	0.300 kg	S55842-Z131-A100
FCA2056-A1	Accessory kit + ACDC (X200)	0.200 kg	S54400-S115-A1
FHA2063-A1	Mounting plate (X200)	0.269 kg	S54400-B116-A1

Batteries

Type	Designation	Weight	Order number
FA2004-A1	Battery (12 V, 12 Ah, VdS)	3.750 kg	A5Q00019354
FA2005-A1	Battery (12 V, 17 Ah, VdS)	5.700 kg	A5Q00019677
BAT12-25	Battery (12 V, 25 Ah, VdS)	7.8 kg	S54302-Z102-A1
FA2007-A1	Battery (12 V, 45 Ah, VdS)	14.500 kg	A5Q00022897
FA2008-A1	Battery (12 V, 65 Ah, VdS)	21.300 kg	A5Q00019357
FHA2061-A1	Mounting kit for batteries	–	S54400-B91-A1

License keys

Type	Designation	Weight	Order number
FCA2033-A1	License key (S1)	0.010 kg	S54400-P154-A1
FCA2034-A1	License key (S2)	0.010 kg	S54400-P155-A1
FCA2035-A1	License key (S3)	0.010 kg	S54400-P156-A1
FCA2036-A1	License key (S4)	0.010 kg	S54400-P157-A1

External printer

Type	Designation	Weight	Order number
DL3750+	Matrix printer (external)	7.300 kg	A5Q00023962
-	Color ribbon for matrix printer DL3750+	0.078 kg	A5Q00023963

Title	Document ID
System documentation	
System description	008836
Product data	008837
Planning	008843
Mounting/Installation	008851
System data sheet	
FS20 – Fire detection system	008955
Data sheets	
FC2020 - fire control panel	009383
FC2030 - fire control panel for modernization	A6V10087532
FC2040 - fire control panel	009384
FC2060 - fire control panel (modular)	A6V10087844
FC2080 - fire control panel (19", modular)	A6V10275515
FT2040 - fire terminal	009386
FT2080 - fire terminal (Touch)	A6V10378271
Fire detection system with integrated single or multi-sector extinguishing	A6V10880701
Network Security Guidelines	A6V101039125
Planning overview	A6V10906627

Related documents such as the environmental declarations, CE declarations, etc., can be downloaded from the following Internet address:

www.siemens.com/bt/download



Guarantee

The application-specific technical data is guaranteed only in combination with the Siemens products listed in the 'Device combinations' section. If third-party products are used, any guarantee provided by Siemens will be invalidated.

Technical data

Fire control panel (4 loops)/(4 loops, P) FC2040 in housing (Comfort)

Supply	Mains voltage	AC 115 / 230 V +10/-15 %
	Power supply	150 W
	Operating voltage	DC 21...28.4 V
	Operating current	Max. 5 A
	Battery capacity	2x 12 V, max. 25 Ah
	Battery monitoring	Yes
	Network monitoring	Yes
Inputs / outputs	Connectable detector series	Sinteso (FDnet)
	Number of addresses	Max. 504
	Number of integrated line cards	2
	Number of lines:	
	• Loops (with loop extension) or	4 (8)
	• Stubs (with loop extension)	8 (16)
	Integrated inputs/outputs:	
	• Alarm RT relay output	1
	• Fault RT relay output	1
	• Monitored alarm outputs	1
• Monitored fault outputs	1	
• Monitored horn outputs	2	
• Freely configurable inputs/outputs	12	
Interfaces	Operating unit	Integrated
	Slots for serial interfaces RS232, RS485	2
	Slots for network modules	2
	Slot for loop extension	2
	Mounting space for cable kit (communication)	2
	Sounder module	Max. 2
	Ethernet port RJ45	1
Ambient conditions	Operating temperature	-8...+42 °C
	Storage temperature	-20...+60 °C
	Air humidity (no condensation permitted)	≤95 % rel.
	Maximum height above sea level	3,700 m
Mechanical data	Dimensions (W x H x D):	
	• Without cover cap	430 x 796 x 160 mm
	• With cover cap	430 x 796 x 183 mm
	Protection category (IEC 60529)	IP30
	Color:	
	• Housing	~RAL 7035 light gray
• Cover cap	~RAL 9010	

Fire control panel (4 loops)/(4 loops, P) FC2040 in housing (Comfort)		
Approvals	VdS	G206110
	LPCB	126bn/03
	FM	3048514
	DNV GL (marine)	MEDB00003UW, See document A6V10400920
Fire control panel (4 loops)/(4 loops, P) FC2040 in housing (Large)		
Supply	Mains voltage	AC 115 / 230 V +10/-15 %
	Power supply	150 W
	Operating voltage	DC 21...28.4 V
	Operating current	Max. 5 A
	Battery capacity	2x 12 V, max. 45 Ah
	Battery monitoring	Yes
	Network monitoring	Yes
Inputs / outputs	Connectable detector series	Sinteso (FDnet)
	Number of addresses	Max. 504
	Number of integrated line cards	2
	Number of lines:	
	• Loops (with loop extension) or	4 (8)
	• Stubs (with loop extension)	8 (16)
	Integrated inputs/outputs:	
	• Alarm RT relay output	1
	• Fault RT relay output	1
	• Monitored alarm outputs	1
• Monitored fault outputs	1	
• Monitored horn outputs	2	
• Freely configurable inputs/outputs	12	
Interfaces	Operating unit	Integrated
	Slots for serial interfaces RS232, RS485	2
	Slots for network modules	2
	Slot for loop extension	2
	Mounting space for cable kit (communication)	2
	Sounder module	Max. 2
	Ethernet port RJ45	1
Ambient conditions	Operating temperature	-8...+42 °C
	Storage temperature	-20...+60 °C
	Air humidity (no condensation permitted)	≤95 % rel.
	Maximum height above sea level	3,700 m

Fire control panel (4 loops)/(4 loops, P) FC2040 in housing (Large)		
Mechanical data	Dimensions (W x H x D):	
	• Without cover cap	430 x 796 x 260 mm
	• With cover cap	430 x 796 x 283 mm
	Protection category (IEC 60529)	IP30
	Color:	
	• Housing	~RAL 7035 light gray
	• Cover cap	~RAL 9010
Approvals	VdS	G206110
	LPCB	126bn/03
	FM	3048514
	DNV GL (marine)	MEDB00003UW, See document A6V10400920